

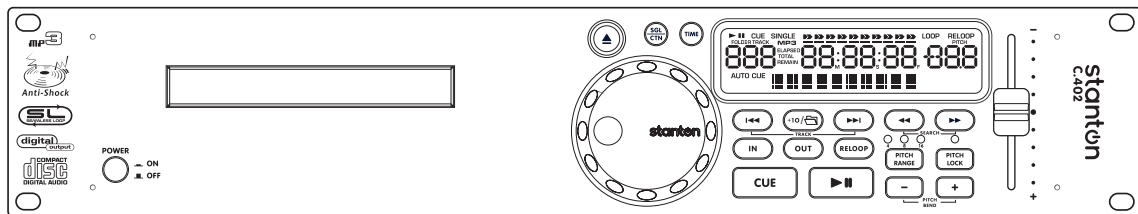

# stanton

## C.402



## USER MANUAL

# IMPORTANT SAFETY PRECAUTIONS

1. Read Instructions - All the safety and operating instructions should be read before this product is operated.
2. Retain Instructions - The safety and operating instructions should be retained for future reference.
3. Heed Warnings - All warnings on the appliance and in the operating instructions should be adhered to.
4. Follow Instructions - All operating and use instructions should be followed.
5. Water and Moisture - The appliance should not be used near water - for example, near a bathtub, washbowl, kitchen sink, laundry tub, in a wet basement, or near a swimming pool, and the like.
6. Wall or Ceiling Mounting - The product should be mounted to a wall or ceiling only as recommended by the manufacturer.
7. Heat - Appliance should be situated away from heat sources such as radiators, heat registers, stoves, or other appliances (including amplifiers) that produce heat.
8. Power Sources - This product should be operated only from the type of power source indicated on the rating label. If you are not sure of the type of power supply to your home, consult your product dealer or local power company. For products intended to operate from battery power, or other sources, refer the operating instructions.
9. Grounding or Polarization - This product may be equipped with a polarized alternating current line plug (a plug having one blade wider than the other). This plug will fit into the power outlet only one way. This is a safety feature. If you are unable to insert the plug fully into the outlet, try reversing the plug. If the plug should still fail to fit, contact your electrician to replace your obsolete outlet. Do not defeat the safety purpose of the polarized plug.
10. Power-Cord Protection - Power-supply cords should be routed so that they are not likely to be walked on or pinched by items placed upon or against them, paying particular attention to the cord in correspondence of plugs, convenience receptacles, and the point where they exit from the appliance.
11. Cleaning - The appliance should be cleaned only as recommended by the manufacturer. Clean by wiping with a cloth slightly damp with water. Avoid getting water inside the appliance.
12. Non-use Periods - The power cord of the appliance should be unplugged from the outlet when left unused for a long period of time.
13. Object and Liquid Entry - Care should be taken so that objects do not fall and liquids are not spilled into the enclosure through openings.
14. Damage Requiring Service - The appliance should be serviced by qualified service personnel when:
  - A. The power-supply cord or the plug has been damaged; or
  - B. Objects have fallen, or liquid has been spilled into the appliance; or
  - C. The appliance has been exposed to rain; or
  - D. The appliance does not appear to operate normally or exhibits a marked change in performance; or
  - E. The appliance has been dropped, or the enclosure damage.
15. Servicing - The user should not attempt any service to the appliance beyond that described in the operating instructions. All other servicing should be referred to qualified service personnel..
16. Ventilation - Slots and openings in the cabinet are provided for ventilation and to ensure reliable operation of the product and to protect it from overheating, and these openings must not be blocked or covered. The openings should never be blocked by placing the product on a bed, sofa, rug, or other similar surface. This product should not be placed in a built-in installation such as a bookcase or rack unless proper ventilation is the manufacturers instructions have been adhered to.
17. Attachments - Do not use attachments not recommended by the product manufacturer as they may cause hazards.
18. Accessories - Do not place this product on an unstable cart, stand, tripod, bracket, or table. The product may fall, causing serious injury to a child or adult, and serious damage to the product. Use only with a cart, stand, tripod, bracket, or table recommended by the manufacturer, or sold with the product. Any mounting of the product should follow the manufacturer's instructions, and should use amounting accessory recommended by the manufacturer.
19. Lightning - For added protection for this product during a lightning storm, or when it is left unattended and unused for long periods of time, unplug it from the wall outlet and disconnect the antenna or cable system. This will prevent damage to the product due to lightning and power-line surges.
20. Replacement Parts - When replacement parts are required, be sure the service technician has used replacement parts specified by the manufacturer or have the same characteristics as the original part. Unauthorized substitutions may result in fire, electric shock, or other hazards.
21. Safety Check - Upon completion of any service or repairs to this product, ask the service technician to perform safety checks to determine that the product is in proper operating condition.
22. This product is in compliance with EUWEEE regulations. Disposal of end of life product should not be treated as municipal waste. Please refer to your local regulations for instructions on proper disposal of this product. 
23. Carts and Stands - The appliance should be used only with a cart or stand that is recommended by the manufacturer. An appliance and cart combination should be moved with care. Quick stops, excessive force, and uneven surfaces may cause the appliance and cart combination to overturn. 
24. This device complies with Part 15 of the FCC Rules. Operation is subject to the following two conditions: (1) this device may not cause harmful interference, and (2) this device must accept any interference received, including interference that may cause undesired operation.



**CAUTION**  
RISK OF ELECTRIC SHOCK  
DO NOT OPEN



**CAUTION:** To reduce the risk of electric shock, do not remove any cover. No user-serviceable parts inside. Refer servicing to qualified service personnel only.



The lightning flash with arrowhead symbol within the equilateral triangle is intended to alert the user to the presence of un-insulated "dangerous voltage" within the products enclosure that may be of sufficient magnitude to constitute a risk of electric shock.



The exclamation point within the equilateral triangle is intended to alert the user to the presence of important operation and maintenance (servicing) instructions in the literature accompanying this appliance.

**CAUTION:** To prevent electric shock, do not use this polarized plug with an extension cord, receptacle or other outlet unless the blades can be fully inserted to prevent blade exposure.

# IMPORTANT TO SAFETY

**WARNING:**

- TO PREVENT FIRE OR SHOCK HAZARD, DO NOT USE THIS PLUG WITH AN EXTENSION CORD, RECEPTACLE OR OTHER OUTLET UNLESS THE BLADES CAN BE FULLY INSERTED TO PREVENT BLADE EXPOSURE.
- TO PREVENT FIRE OR SHOCK HAZARD. NO NOT EXPOSE THIS APPLIANCE TO RAIN OR NOISTURE.
- TO PREVENT ELECTRICAL SHOCK, MATCH WIDE BLADE PLUG TO WIDE SLOT AND FULLY INSERT.

**CAUTION:**

1. Handle the power supply cord carefully  
Do not damage or deform the power supply cord. If it is damaged or deformed, it may cause electric shock or malfunction when used. When removing from wall outlet, be sure to remove by holding the plug attachment and not by pulling the cord.
2. In order to prevent electric shock, do not open the top cover. If a problem occurs, contact your dealer.
3. Do not place metal objects or spill liquid inside the CD player. Electric shock or malfunction may result.

Please, record and retain the Model name and serial number of your set shown on the rating label.

Model No. \_\_\_\_\_ Serial No. \_\_\_\_\_

• FOR U.S.A. & CANADA MODEL ONLY

**CAUTION**

TO PREVENT ELECTRIC SHOCK DO NOT USE THIS (POLARIZED) PLUG WITH AN EXTENSION CORD, RECEPTACLE OR OTHER OUTLET UNLESS THE BLADES CAN BE FULLY INSERTED TO PREVENT BLADE EXPOSURE.

**NOTE:**

This CD player uses a semiconductor laser. To allow you to enjoy music at a stable operation, it is recommended to use this in a room of 5°C 41°F - 35°C 95°F.

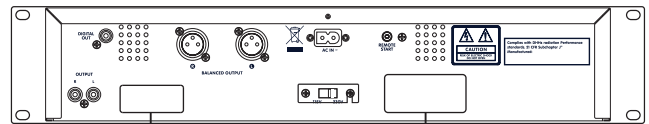

CLASS 1 LABEL

RATING LABEL

**CAUTION:**

USE OF CONTROLS OR ADJUSTMENTS OR REFORMANCE OF PROCEDURES OTHER THAN THOSE SPECIFIED HEREIN MAY RESULT IN HAZARDOUS RADIATION EXPOSURE.

THE COMPACT DISC PLAYER SHOULD NOT BE ADJUSTED OR REPAIRED BY ANYONE EXCEPT PROPERLY QUALIFIED SERVICE PERSONNEL.

DOUBLE INSULATED - WHEN SERVICING, USE ONLY IDENTICAL REPLACEMENT PARTS.

**NOTE:**

This unit may cause interference to radio and television reception.



**CAUTION:** TO REDUCE THE RISK OF ELECTRIC SHOCK, DO NOT REMOVE THE COVER (OR BACK) . NO USER-SERVICEABLE PARTS INSIDE.

REFER SERVICING TO QUALIFIED SERVICE PERSONNEL.



The lightning flash with arrowhead symbol, within an equilateral triangle, is intended to alert the user to the presence of un-insulated "dangerous voltage" within the product's enclosure that may be of sufficient magnitude to constitute a risk of electric shock to persons.



The exclamation po within an equilateral triangle is intended to alert the user to the presence of important operating and maintenance (servicing) instructions in the literature accompanying the appliance.

• **Line Voltage Selection (for multiple voltage model only)**

- ★ The desired voltage may be set with the VOLTAGE SELECTOR switch on the rear panel, using a screwdriver. 
- ★ Do not twist the VOLTAGE SELECTOR switch with excessive force as this may cause damage.
- ★ If the VOLTAGE SELECTOR switch does not move smoothly, please contact a qualified serviceman.

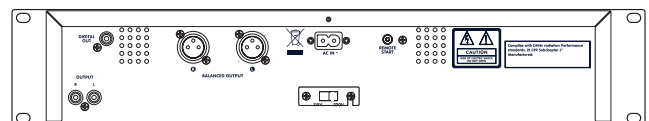

## NOTE ON USE

- Allow for sufficient heat dispersion when installed in a rack.
- Handle the power cord carefully.
- Hold the plug when unplugging the cord.
- Keep the set free from moisture, water, and dust.
- Unplug the power cord when not using the set for long periods of time.
- Do not obstruct the ventilation holes. (For sets with ventilation holes.)
- Do not place foreign objects in the set.
- Do not let insecticides, benzene, and thinner come in contact with the set.
- Never disassemble or modify the set in any way.
- For 120 volt use in USA, USA nema style 120 volt plug. For other countries, use proper plug for the local outlet.

## MAIN FEATURES

- (1) 8 times oversampling, 1 bit D/A converter.
- (2) 4 different scan speeds.
- (3) Frame search.
- (4) Auto cue.
- (5) Pitch display.
- (6) Digital output.

### MAIN UNIT

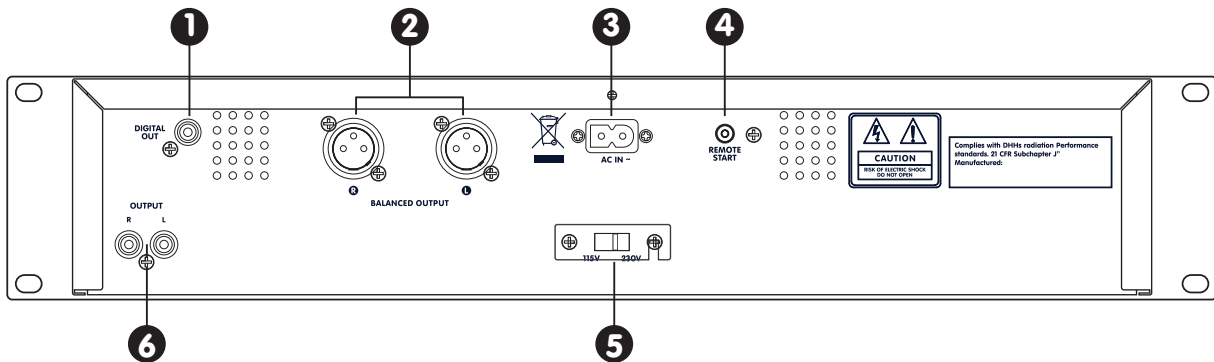

- |   |                          |
|---|--------------------------|
| (1) DIGITAL OUT SOCKET                            | (2) BALANCED OUTPUT L/R  |
| (3) AC IN   | (4) REMOTE START         |
| (5) VOLTAGE SELECTOR (Just for Dual Voltage only) | (6) AUDIO OUTPUT L AND R |

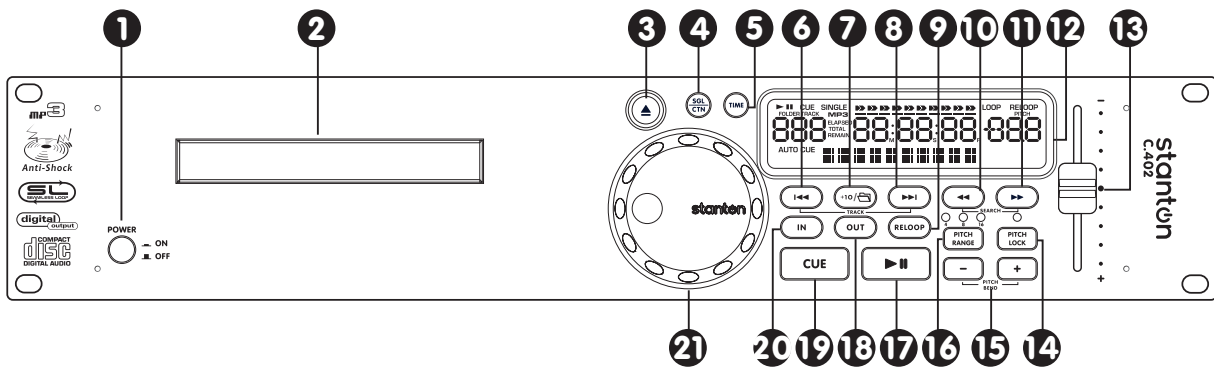

- |                   |                    |                |                   |
|-------------------|--------------------|----------------|-------------------|
| (1) POWER BUTTON  | (2) DISC HOLDER    | (3) OPEN/CLOSE | (4) SGL/CTN       |
| (5) TIME          | (6) TRACK BACKWARD | (7) +10/FOLDER | (8) TRACK FORWARD |
| (9) RELOOP        | (10) F.BACKWARD    | (11) F.FORWARD | (12) LCD          |
| (13) PITCH SLIDER | (14) PITCH LOCK    | (15) PITCH +/- | (16) PITCH RANGE  |
| (17) PLAY/PAUSE   | (18) LOOP OUT      | (19) CUE       | (20) LOOP IN      |
| (21) JOG WHEEL    |                    |                |                   |

## MAIN FEATURES

### LCD

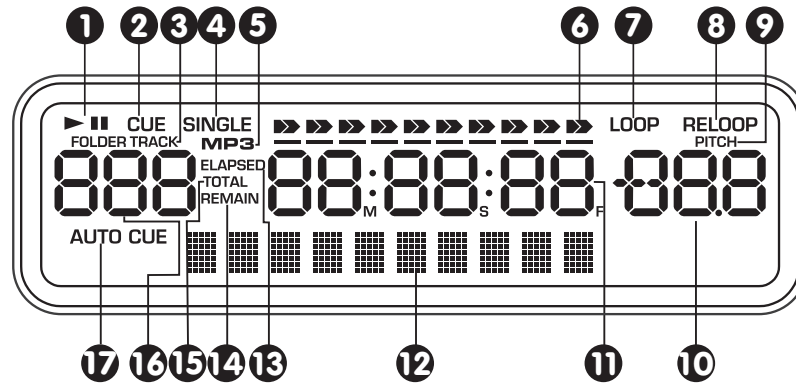

- |                          |                       |                             |
|--------------------------|-----------------------|-----------------------------|
| (1) PLAY/PAUSE INDICATOR | (2) CUE INDICATOR     | (3) FOLDER/TRACK INDICATOR  |
| (4) SINGLE INDICATOR     | (5) MP3 INDICATOR     | (6) TIME BAR INDICATOR      |
| (7) LOOP INDICATOR       | (8) RELOOP INDICATOR  | (9) PITCH INDICATOR         |
| (10) PITCH METER         | (11) TIME DISPLAY     | (12) CHARACTER DISPLAY      |
| (13) ELAPSED INDICATOR   | (14) REMAIN INDICATOR | (15) TOTAL REMAIN INDICATOR |
| (16) TRACK INDICATOR     | (17) AUTO CUE         |                             |

## PREPARATIONS

### 1. Checking the Contents

Check that the carton contains the following items:

- 1) Main unit 2) Pair of RCA cables 3) Operating instructions (this booklet) 4) Power cord

## NAMES AND FUNCTIONS

### Main Unit

#### (1) DIGITAL OUT SOCKET

Coaxial (S/P DIF) digital output for use with audio devices equipped with coaxial (S/P DIF) digital input such as digital mixing consoles and computer audio cards.

#### (2) BALANCED OUTPUT

Connect other appliances with balanced output easily.

#### (3) AC IN

Plug in the power supply cable here.

#### (4) REMOTE START

The player is paused when a Remote Switch is pressed once; when touched again, it starts playing.

#### (5) VOLTAGE SELECTOR (Just for Dual Voltage only)

Select 115V or 230V according to the local voltage.

#### (6) AUDIO OUT

The audio signals from each player are output from these jacks.

## Main Unit

---

**(1) POWER (Power ON/OFF Switch)**

When the POWER switch is pressed, the power turns on.

**(2) DISC HOLDER**

Place the discs in the holder. Press the OPEN/CLOSE button to open and close the disc holder.

**(3) OPEN/CLOSE**

Press this button to open and close the disc holder. The disc holder cannot be opened during playback, so stop playback before pressing the button.

**(4) SGL/CTN (Single/Continuous Button)**

Press this button to switch between single and continuous play modes. SINGLE mode is indicated by the SINGLE indicator on the LCD.

**(5) TIME (Time Button)**

Press this button to switch the time display among the elapsed time and remaining time and total remaining time of the disc.

**(6) ⏮ TRACK BACKWARD**

Use this button to go back to the beginning of the current track or select a previous track for playing.

**(7) +10/📁 FOLDER**

CD mode, use this button to skip ahead 10 tracks.  
Mp3 mode, press this button to select next folder.

**(8) ⏭ TRACK FORWARD**

Use this button to skip to the next CD track.

**(9) RELOOP**

Depending on mode, as explained further, this button is used for either repeating a previously set loop or seamlessly stuttering on the last set cue point.

**(10),(11) ⏪ ⏩ F.FORWARD/F.BACKWARD**

Press these buttons to perform the scan function during pause mode or during play mode.

**(12) LCD**

**(13)PITCH SLIDER**

Use the slider to adjust the CD pitch. Slide up to decrease the pitch, down to increase the pitch.

**(14)PITCH LOCK**

Use this button to enable or disable BPM adjustment with the pitch sliders. BPM adjustment with the pitch sliders is disabled when the PITCH LED lights.

**(15)PITCH +/- BUTTON**

+ The CD speeds up while this button is pressed. Release the button to return to the original BPM.  
- The CD slows down while this button is pressed. Release the button to return to the original BPM.

**(16)PITCH RANGE**

Choose from pitch percentages of 4%, 8% and 16%.

**(17)PLAY/PAUSE**

Use this button to start playback. Press once to start playback, once again to set the pause mode, and once more to resume playback.

**(18)LOOP OUT**

Used for setting the end loop point and releasing the loop action.

**(19)CUE (Cue Button)**

Press the CUE button during playback to return to the position at which playback started.

**(20)LOOP IN**

Used for setting a start loop point and releasing the loop action.

**(21)JOG WHEEL(JOG dial)**

When the dial is turned during CD pause, the point at which the sound is being produced moves by a number of frames corresponding to the number of clicks. Clockwise moves the point forward, counterclockwise moves the point backward.

## LCD

---

### (1) PLAY / PAUSE INDICATOR

When the unit is in play mode the "PLAY" indicator will glow, when the drive is in pause mode the "PAUSE" indicator will glow.

### (2) CUE INDICATOR

This indicator will glow when the unit is in CUE mode and will flash every time a new CUE POINT is set.

### (3) FOLDER/TRACK INDICATOR

This indicator shows you if you are looking at the track number or the folder number.

### (4) SINGLE INDICATOR

This indicates that the CD drive is in single play mode. The track will play once and return to CUE mode. If the single indicator is not on, the unit is in continuous mode and the drive will play all the remaining tracks on the disc until you stop play or power is interrupted.

### (5) MP3 INDICATOR

This will indicate that a Mp3 disc is loaded in the drive.

### (6) TIME BAR INDICATOR

This bar gives a visual approximation of a track's or disc's remaining time. This bar will begin to flash when a CD is ending.

### (7) LOOP INDICATOR

Appears when the CD is repeating a particular area with the music on the CD.

### (8) RELOOP INDICATOR

Appears when the CD has had a loop set previously and can go back to loop again.

### (9) PITCH INDICATOR

Indicator will light up when the Pitch is activated.

### (10) PITCH METER

Shows the percentage change in pitch of the song. The meter will display the pitch percentage applied by the PITCH SLIDER.

### (11) TIME DISPLAY

This displays the Minutes, Seconds, and Frames. The meter will display either the elapsed time, or remaining time of a track.

### (12) CHARACTER DISPLAY

This will display the name of the file, artist, and title when a disc is loaded.

### (13) ELAPSED INDICATOR

When the ELAPSED indicator is visible, this indicates that the Time Display is showing elapsed track time.

### (14) REMAIN INDICATOR

When the REMAIN indicator is visible, this indicates that the Time Display is showing remaining track time.

### (15) TOTAL REMAIN INDICATOR

When TOTAL and REMAIN are visible, this indicates that the Time Display is showing total remaining disc time.

### (16) TRACK INDICATOR

This 3-digit indicator displays the current track. The number displayed in the track indicator is a direct reference to a track being selected or a track in play, pause, or cue mode.

### (17) AUTO CUE

This will indicate if the Auto Cue is on or off. Press and hold the SGL/CTN for 1 sec. to turn the Auto Cue function on and off.



## 1. Opening and Closing the Disc Holder

- Turn the unit power on. Press the OPEN/CLOSE button to open the disc holder.
- The disc holder cannot be opened during playback to prevent playback from being interrupted if the OPEN/CLOSE button is pressed accidentally. Stop the playback first, then press the OPEN/CLOSE button.

## 2. Loading discs

- Hold the disc by the edges and place it in the disc holder, then press the OPEN/CLOSE button again to close the disc holder. The unit will show the total track number and the total playing time for about 2 seconds then enter the cue condition. The cue point will be set to the music starting point of the first track automatically.

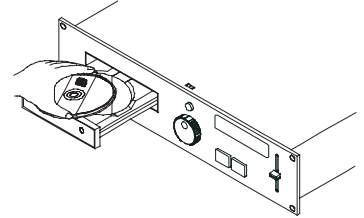

### CAUTION:

- Do not place any foreign objects in the disc holder, and do not place more than one disc in the disc holder at a time.
- Do not push the disc holder in manually when the power is off, as this may result in malfunction and damages the player.

## 3. Selecting Tracks

- Press the TRACK button once to move to next higher or lower track.
- Hold the TRACK button to change tracks continuously at a higher speed.
- When a new track is selected during playback, playback begins as soon as the skip search operation is completed.
- If the TRACK **▶▶** button is pressed while at the last track, the first track is selected. In the same way, if the TRACK **◀◀** button is pressed while at the first track, the last track is selected.

## 4. Starting Playback

- Press the PLAY/PAUSE button during the pause or cue condition to start playback. The PLAY indicator will light.
- The point at which playback starts is automatically stored in the memory as the cue point. The pickup then returns to the cue point when the CUE button is pressed. (Back Cue)



Figure 4-1

## 5A. Stopping Playback

There are two ways to stop playback.

1. Press the PLAY/PAUSE button during playback to pause at that point.
2. Press the CUE button during playback to return to the cue point and enter pause condition.(Back Cue)

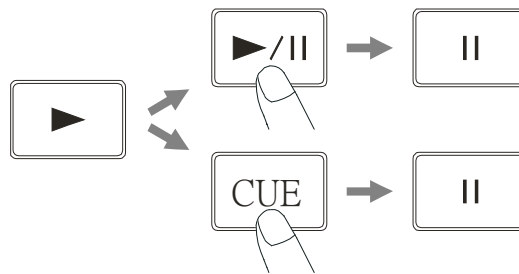

Figure 5-1



## 5B. Pausing

- Press the PLAY/PAUSE button to switch between play and pause.
- The play indicator flashes when the pause mode is set.
- Figure 5-2 shows the relationship between play and pause.

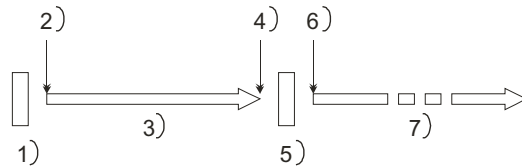

Figure 5-2

- 1) The player has completed the cue or pause operation and is waiting for the play start command.
- 2) PLAY/PAUSE button is pressed and player enters play mode.
- 3) Playing.
- 4) The PLAY/PAUSE button is pressed and the unit enters pause mode.
- 5) Pausing.
- 6) Playback resumes when the PLAY/PAUSE button is pressed again.
- 7) Playing.

## 6. Cueing

- "Cueing" is the process of preparing for playback.
- Press the CUE button, the player will enter cue mode. The playback returns to the cue point and the player enters the pause condition. The cue indicator lights up and the play indicator flashes. When the PLAY/PAUSE button is pressed, playback starts from the cue point.
- When the track search operation is completed after pressing the SKIP buttons, the player automatically finds the position at which the sound starts and cues there(Auto Cue).
- If the CUE button is pressed after the search operation or the scanning operation, playback returns to the cue point and enter pause condition.
- Figure 6-1 shows the relationship between the play and back cue operations.

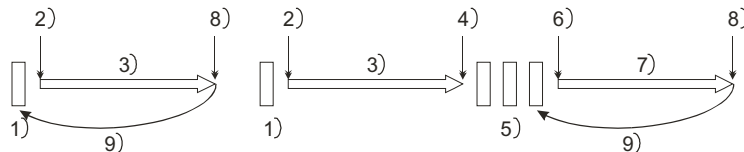

Figure 6-1

- 1) The player has completed the cue or pause operation and is waiting for the play start command.
- 2) When the PLAY/PAUSE button is pressed, playback starts and the cue point is stored in the memory.
- 3) Playing.
- 4) The pause mode is set when the PLAY/PAUSE button is pressed again.
- 5) Pausing.
- 6) The PLAY/PAUSE button is pressed again;
- 7) Playing.
- 8) Press the CUE button.
- 9) The pickup returns to the cue point.(Back Cue)

- Cue point setting:

When play starts from pause by pressing the IN button or by using Scanning or Frame Search, or if you skip to a new track by using the skip button, the begin play point will be set to the new cue point.

When a new cue point is set, the cue indicator lights by flashing for about 1 second.

NOTE: During cue mode, if the CUE button is pressed and held, playback will start from the cue point. When the button is released, the player will return to the cue mode automatically. This allows you to check the cue point.

## 7. Jog Wheel - The jog wheel serves two functions depending on the current operating mode:

- The jog wheel will act as a slow frame search control when the unit is in pause or cue mode allowing you to set a specific cue point or find a particular starting point.
- The wheel also works as a momentary pitch bend during playback. Turning the wheel clockwise will increase the pitch percentage up to +16%, and turning the wheel in the counterclockwise direction will decrease the pitch percentage up to -16%. The pitch bend will be determined on how fast you turn the wheel.

## 8. Scanning (Fast forward/Fast backward)

- Scanning is a function for moving quickly forward or backward in the track when the ◀ or ▶ button is pressed.
- The scanning speed depends on how long you hold the button.
- Press and hold the ◀ or ▶ to begin scanning. The disc moves rapidly forward or backward and the sound is played. The current scan point is indicated on the LCD.
- Press and hold the ▶ to scan in the forward scanning, ◀ to scan in the reverse scanning.

## 9. Time display

### MP3 MODE

Press TIME button to select time display MP3 mode:

- (1) Elapsed time of a track.
- (2) Remaining time of a track.

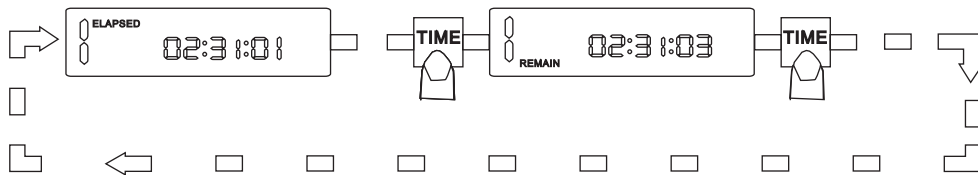

Figure 9-1

### CD MODE

Press this button to select the time display .

It switches between the elapsed time and remaining time and total remaining time of the disc.

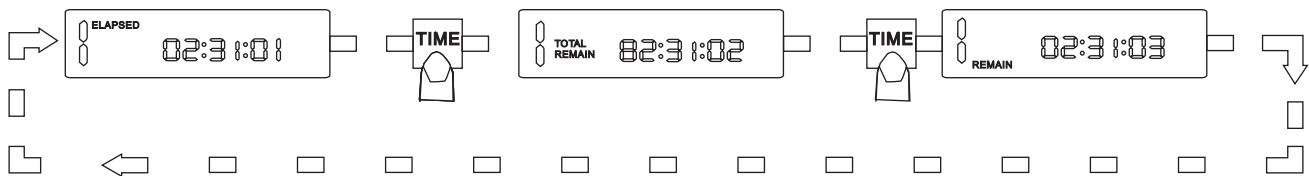

Figure 9-2

## 10. Matching the Beats Per Minute (BPM)

There are three tools available for matching the BPM :

- (1) Use the pitch slider to adjust the BPM statically.
- (2) Use the PITCH BEND buttons to change the BPM temporarily.
- (3) Use the JOG WHEEL to change the BPM temporarily.

### 1) Pitch Slider

- (1) To adjust the BPM by sliding the pitch slider up or down, you must first press the PITCH button to turn on the Pitch Slider.
- (2) Slide the pitch slider up to decrease BPM, or down to increase BPM. The adjustment range is switchable from +/- 4%, +/- 8% to +/- 16%.

### 2) Pitch Bending

- The BPM increases or decreases respectively while the PITCH BEND+ or PITCH BEND- button is pressed.
- The BPM increase depends on how long you hold the button. If you hold the button for about 1/2 second, the BPM will go either to +16% for PITCH BEND+ or -16% for PITCH BEND-. If you tap the button, the BPM will only change a little so you can change the beat slightly without audible changes in the music.
- The CD will return to the tempo indicated by the Pitch slider when you let go of the PITCH BEND + or - button.

## BEFORE SWITCHING OFF THE POWER

### CAUTION:

Do not forcibly close the disc holder when the power is off.

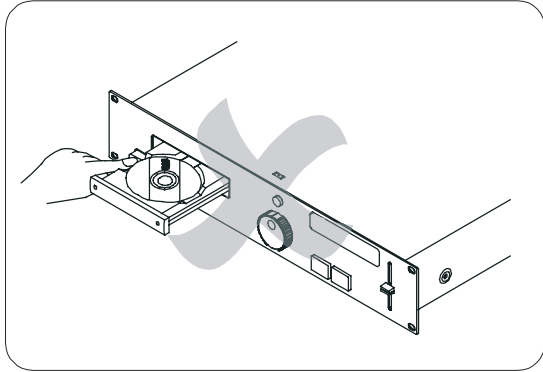

Do not switch off the power when the disc holder is open.

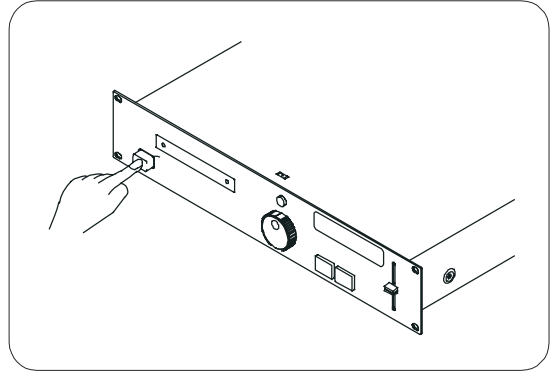

To avoid damage, please don't switch the power until the disc holder has been closed with the OPEN/CLOSE button and the LCD displays "no disc" or "time code" shows.

## COMPACT DISCS

### 1. Precautions on handling compact discs

- Do not allow fingerprints, oil or dust to get on the surface of the disc.  
If the disc is dirty, wipe it off with a soft dry cloth.
- Do not use benzene, thinner, water, record spray, electrostatic-proof chemicals, or silicone-treated cloths to clean discs.
- Always handle discs carefully to prevent damaging the surface; in particular when removing a disc from its case or returning it.
- Do not bend the disc.
- Do not apply heat.
- Do not enlarge the hole in the center of the disc.

- Do not write on the label (printed side) with a hard-tipped implement such as a pencil or ball point pen.
- Condensation will form if a disc is brought into a warm area from a colder one, such as outdoors in winter. Do not attempt to dry the disc with a hair dryer, etc.

### 2. Precaution on storage

- After playing a disc, always unload it from the player.
- Always store the disc in the jewel case protect from dirt or damage.
- Do not place discs in the following areas:
  - (1) Areas exposed to direct sunlight for a considerable time.
  - (2) Areas subject to accumulation of dust or high humidity.
  - (3) Areas affected by heat from indoor heaters, etc.

## SPECIFICATIONS

### GENERAL

Dimensions:	482(W) x 88.8(H) x 266(D) mm 19"(W) x 3 1/2"(H) x 10 1/2"(D)
Weight:	5.5 kgs / 12.1 lbs
Power supply:	Dual Voltage: AC 115/230V, 50/60Hz Single Voltage: AC 100V, 50/60Hz (For Japan) AC 110V, 60Hz (For Taiwan) AC 120V, 60Hz (For U.S.A., Canada, Mexico) AC 220V, 50Hz (For United Arab Emirates, Chile, Argentina) AC 220V, 60Hz (For Philippines) AC 230V, 50Hz (For Europe, New Zealand, South Africa, Singapore, Israel) AC 240V, 50Hz (For Australia, U.K)
Power consumption:	20W

## WARRANTY & RETURN POLICY

### Warranty

Through Stanton's authorized dealers around the World, Stanton, or one of Stanton's authorized distributors outside the U.S., will, without charge, repair or replace, at the sole discretion of the entity responsible for making the repair or providing the replacement, any Stanton merchandise proved defective in material or workmanship for a period of one (1) year following the date of original purchase. Exceptions to this warranty are as noted below:

The warranty for mechanical parts which are subject to wear and tear are limited to the earlier of either thirty (30) days following the date of original purchase or the following number of cycles: Faders - 15,000; Rotary potentiometers - 10,000; and Switches - 10,000.

Stanton will warrant all replacement parts and repairs for ninety (90) days from the date of original shipment. Repairs made necessary by reason of misuse, alteration, normal wear, or accident are not covered under this warranty.

### Returns

Authorized Stanton dealers are only authorized to sell and distribute merchandise within a specific country. All goods requiring warranty repair or replacement must be returned (freight prepaid if not hand-delivered) to the authorized Stanton dealer from whom the merchandise was purchased and in the same country where the merchandise was purchased. For purposes of purchases made via the Internet, the merchandise must be returned to the authorized Stanton dealer in the country where the authorized Stanton dealer which sold the merchandise to purchaser is located and not the authorized Stanton dealer in the country where the purchaser is located or the country in which the merchandise was received. Any returns to a non-authorized dealer or to an authorized Stanton dealer not in the same country as the merchandise was intended to be sold or as set forth above will void this warranty.

To initiate a warranty repair, you must contact the authorized Stanton dealer from whom you purchased the merchandise, and follow such authorized Stanton dealer's return policy.

Stanton assumes no risk and shall be subject to no liability for damage or loss resulting from the specific use or application made of the merchandise. Stanton's liability for any claim, whether based on breach of contract, negligence, infringement of any rights of any party, or product liability, and relating to the merchandise shall not exceed the price received by Stanton from our purchase of such merchandise. In no event will Stanton be liable for any special, incidental or consequential damages (including loss of use, loss of profit and claims of third parties) however caused, whether by the negligence of Stanton or otherwise. To the extent permitted by law and except as otherwise provided above, Stanton disclaims any express or implied warranties of merchantability or fitness for a particular purpose.

The above warranty provides you with specific legal rights. You may also have additional rights, which are subject to variation from state to state and country to country.

If there is a dispute regarding the warranty of merchandise that does not fall under the warranty conditions stated above, please include a written explanation with the merchandise when returned pursuant to the terms and conditions set forth herein.

Please register your product online at [www.stantondj.com](http://www.stantondj.com).